

Deep groove ball bearings, single row

Principal dimensions			Basic load ratings		Fatigue load limit Pu	Speed ratings		Mass	Designation
d	D	B	dynamic	static		Reference speed	Limiting speed		
mm			kN		kN	r/min		kg	-
45	100	36	52,7	31,5	1,34	-	4500	1,15	62309-2RS1

* - SKF Explorer bearing

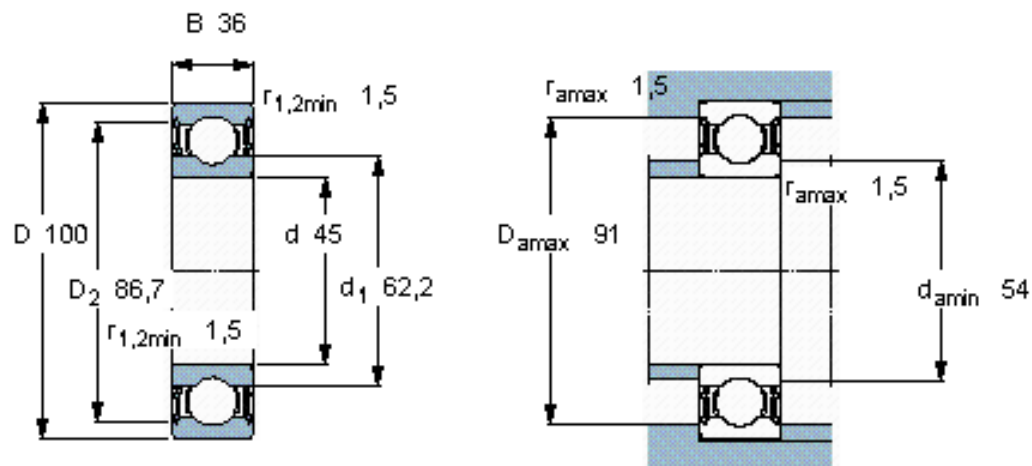

Calculation factors

k_r 0,03

f_0 13