

Deep groove ball bearings, single row

Principal dimensions			Basic load ratings		Fatigue load limit Pu	Speed ratings		Mass	Designation
d	D	B	dynamic	static		Reference speed	Limiting speed		
mm			kN	C0	kN	r/min		kg	* - SKF Explorer bearing
40	90	33	41	24	1,02	-	5000	0,89	62308-2RS1

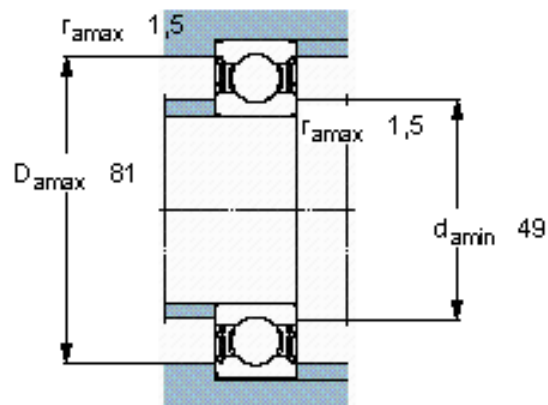
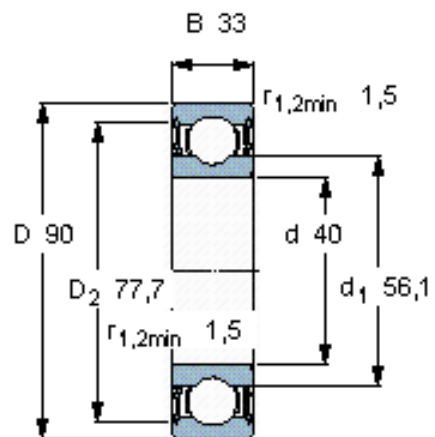

Calculation factors

k_r 0,03
f₀ 13