

Deep groove ball bearings, single row

Principal dimensions			Basic load ratings		Fatigue load limit Pu	Speed ratings		Mass	Designation
d	D	B	dynamic	static		Reference speed	Limiting speed		
mm			kN		kN	r/min		kg	-
30	72	27	28,1	16	0,67	-	6300	0,48	62306-2RS1

* - SKF Explorer bearing

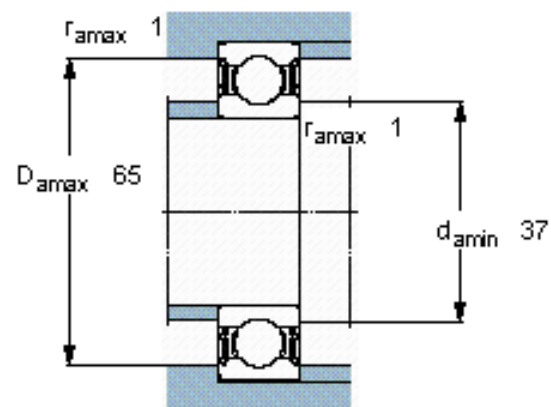
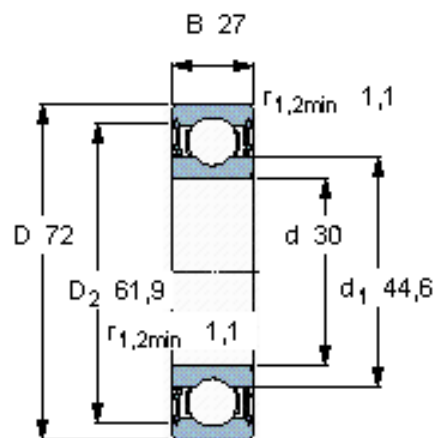

Calculation factors

k_r 0,03
f₀ 13