

### Deep groove ball bearings, single row

Principal dimensions			Basic load ratings		Fatigue load limit Pu	Speed ratings		Mass	Designation
d	D	B	dynamic	static		Reference speed	Limiting speed		
mm			kN		kN	r/min		kg	-
10	35	17	8,06	3,4	0,143	-	15000	0,06	62300-2RS1

\* - SKF Explorer bearing

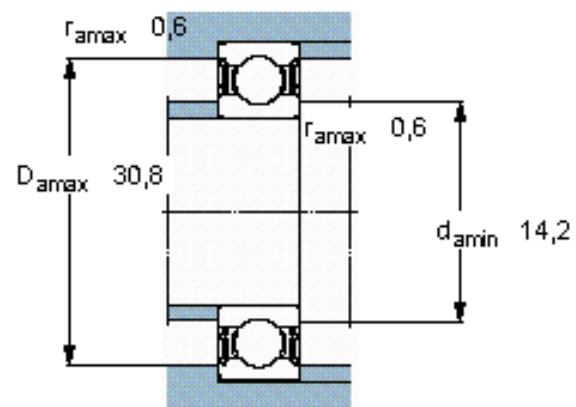
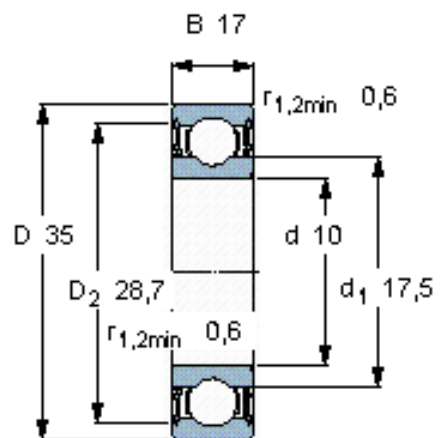

#### Calculation factors

k<sub>r</sub> 0,03  
f<sub>0</sub> 11