

Deep groove ball bearings, single row

Principal dimensions			Basic load ratings		Fatigue load limit Pu	Speed ratings		Mass	Designation
d	D	B	dynamic	static		Reference speed	Limiting speed		
mm			kN	C0	kN	r/min		kg	* - SKF Explorer bearing
65	120	31	55,9	40,5	1,73	-	3600	1,25	62213-2RS1

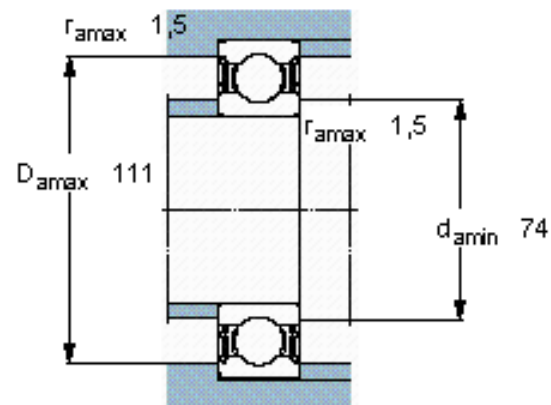
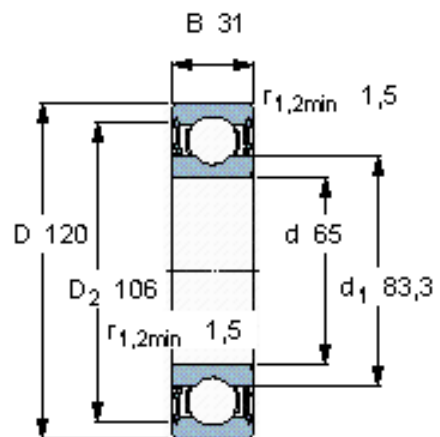

Calculation factors

k_r 0,025
f₀ 15