

Taper roller bearings, single row

Principal dimensions			Basic load ratings		Fatigue load limit Pu	Speed ratings		Mass	Designation
d	D	T	dynamic	static		Reference speed	Limiting speed		
mm			kN		kN	r/min		kg	* - SKF Explorer bearing
85	180	63,5	402	530	60	2800	4000	6,85	32317 J2

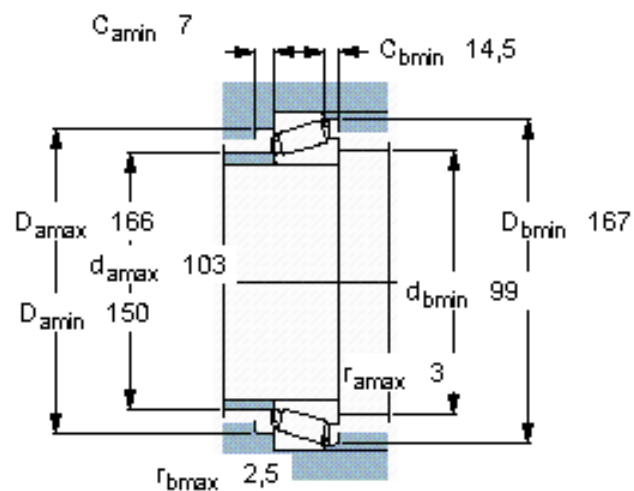
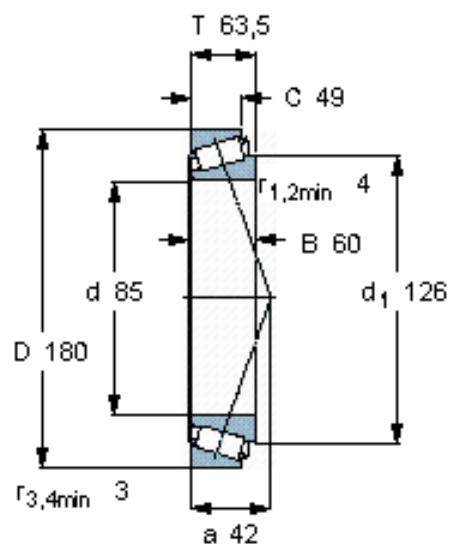

Calculation factors

e 0,35
 γ 1,7
 γ_0 0,9