

Taper roller bearings, single row

Principal dimensions			Basic load ratings		Fatigue load limit Pu	Speed ratings		Mass	Designation
d	D	T	dynamic	static		Reference speed	Limiting speed		
mm			kN		kN	r/min		kg	* - SKF Explorer bearing
240	360	76	935	1800	160	1200	1600	27,5	32048 X

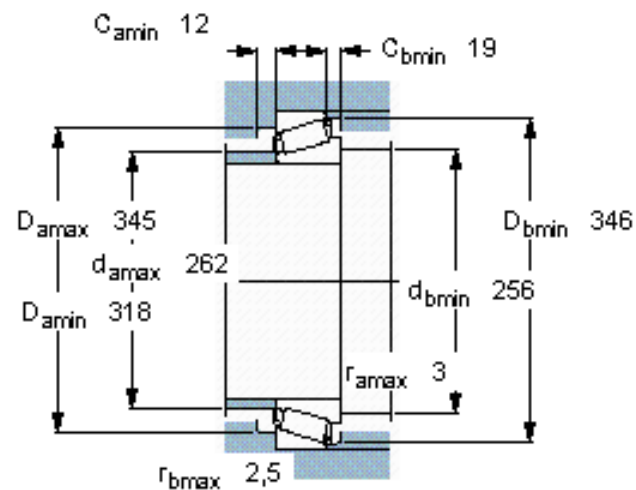
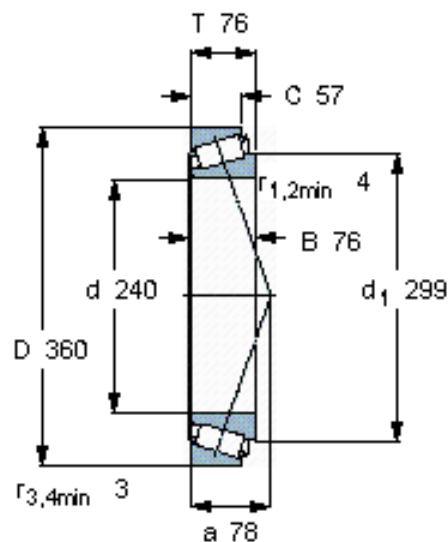

Calculation factors

e 0,46

Y 1,3

Y_0 0,7