

Taper roller bearings, single row

Principal dimensions			Basic load ratings		Fatigue load limit Pu	Speed ratings		Mass	Designation
d	D	T	dynamic	static		Reference speed	Limiting speed		
mm			kN		kN	r/min		kg	* - SKF Explorer bearing
95	145	32	168	270	30,5	3200	4300	1,80	32019 X/Q

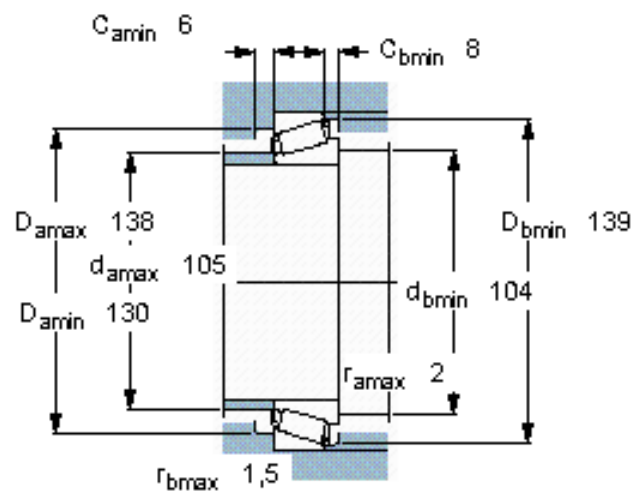
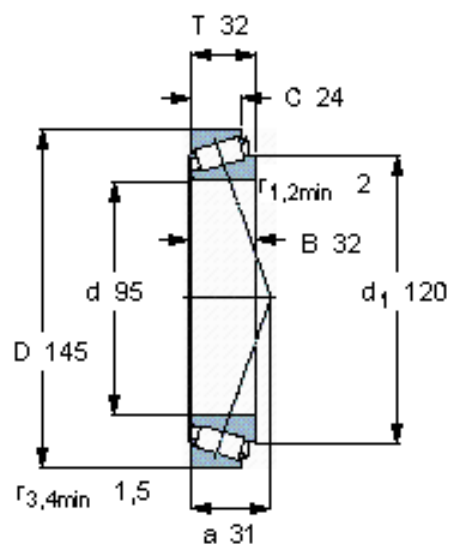

Calculation factors

e 0,44

Y 1,35

$Y_0 0,8$